

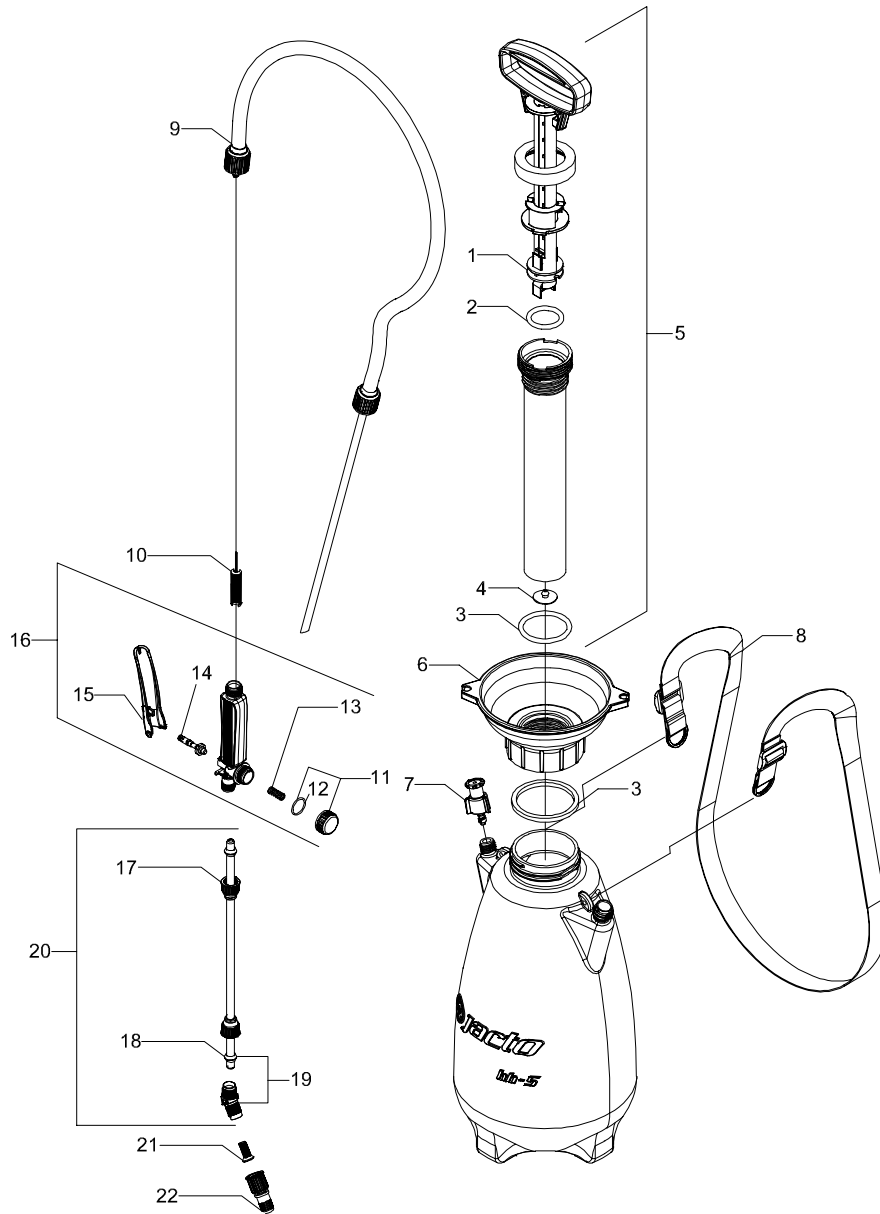





















# PARTS CATALOG

## JACTO HH-5



| No | CODE    | DESCRIPTION                 | IMAGE   | QTY. | UTILIZATION               | NCM HS CODE | EAN BARCODE   |
|----|---------|-----------------------------|---|------|---------------------------|-------------|---------------|
| 1  | 1232054 | FASTENER                    |    | 1    | HH-5                      | 8424.90.90  | 7896660821870 |
| 2  | 1232050 | PISTON RING                 |    | 1    | HH-5                      | 4016.93.00  | 7896660821795 |
| 3  | 1232052 | SEALS                       |    | 1    | HH-5                      | 4016.93.00  | 7896660821856 |
| 4  | 1232057 | DIAPHRAGM                   |    | 1    | HH-5                      | 4016.93.00  | 7896660821894 |
| 5  | 1232055 | PUMP ASSEMBLY               |    | 1    | HH-5                      | 8413.20.00  | 7896660821887 |
| 6  | 1232056 | LID TANK                    |    | 1    | HH-5                      | 8424.90.90  | 7896660821788 |
| 7  | 1232053 | PRESSURE RELIEF VALVE       |    | 1    | HH-5                      | 8481.40.00  | 7896660821863 |
| 8  | 1232067 | COMPLETE BELT               |  | 1    | HH-5                      | 8424.90.90  | 7896660820859 |
| 9  | 1232058 | COMPLETE HOSE FOR LP3       |  | 1    | HH-5                      | 8424.90.90  | 7896660821917 |
| 10 | 1168418 | FILTER LP-3                 |  | 1    | XP, HDBL, PJB             | 8424.90.90  | 7909436913560 |
| 11 | 1168544 | TRIGGER VALVE CAP AND SEAL  |  | 1    | XP, HDBL PJB              | 3926.90.90  | 7909436921138 |
| 12 | 1220934 | ORING ORI-19                |  | 1    | XP, HDBL, PJB             | 4016.93.00  | 7909436906784 |
| 13 | 1222660 | SPRING                      |  | 1    | XP, HD, PJB               | 7320.90.00  | 7909436921022 |
| 14 | 1168422 | NEEDLE LP-3 AND RINGS       |  | 1    | XP, HD, PJB               | 8481.90.90  | 7899144899037 |
| 15 | 1168421 | TRIGGER VALVE LEVER LP-3    |  | 1    | XP, HD, PJB               | 8424.90.90  | 7909436921053 |
| 16 | 1168419 | TRIGGER VALVE ASSEMBLY LP-3 |  | 1    | XP, HD, PJB               | 8481.80.99  | 7899144898900 |
| 17 | 1220969 | SCREW CAP 11/16             |  | 1    | PJH, PJ, XP, HD, PJB, DJB | 3926.90.90  | 7909436924924 |

# JACTO HH-5

| No | CODE    | DESCRIPTION                 | IMAGE   | QTY. | UTILIZATION                  | NCM<br>HS CODE | EAN<br>BARCODE |
|----|---------|-----------------------------|---|------|------------------------------|----------------|----------------|
| 18 | 1220972 | CONE PACKING                |  | 1    | PJH, PJ, XP, HD,<br>PJB, DJB | 3926.90.90     | 7909436925037  |
| 19 | 635276  | JOINT AND CONE PACKING      |  | 1    | PJH, PJ, XP, HD,<br>PJB, DJB | 3917.40.90     | 7909436931311  |
| 20 | 1224677 | LANCE PJB-8C COMPLETE       |  | 1    | HH-5                         | 8424.90.90     | 7896660896007  |
| 21 | 1168545 | NOZZLE FILTER M50/60        |  | 1    | PJH, PJ, XP, HD,<br>PJB, DJB | 8424.90.90     | 7896660860053  |
| 22 | 1222664 | BLUE ADJUSTABLE CONE NOZZLE |  | 1    | PJH, PJ, XP, HD,<br>PJB, DJB | 8424.90.90     | 7909436928588  |